

SINGER
46K48,K49,K53

Form K6045
Supersedes K1066

Illustrated List of Parts

FOR

Nos. 46K48, 46K49 and
46K53 MACHINES

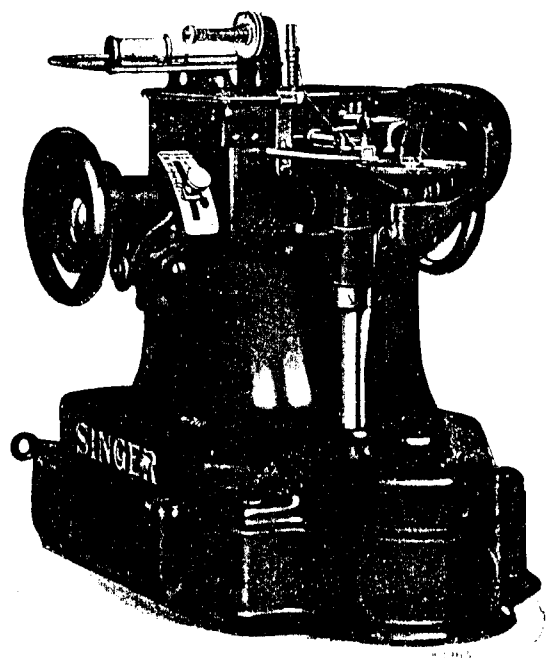

Machine No. 46K48.

** A Trade Mark of
THE SINGER MANUFACTURING COMPANY

From the library of: Diamond Needle Corp

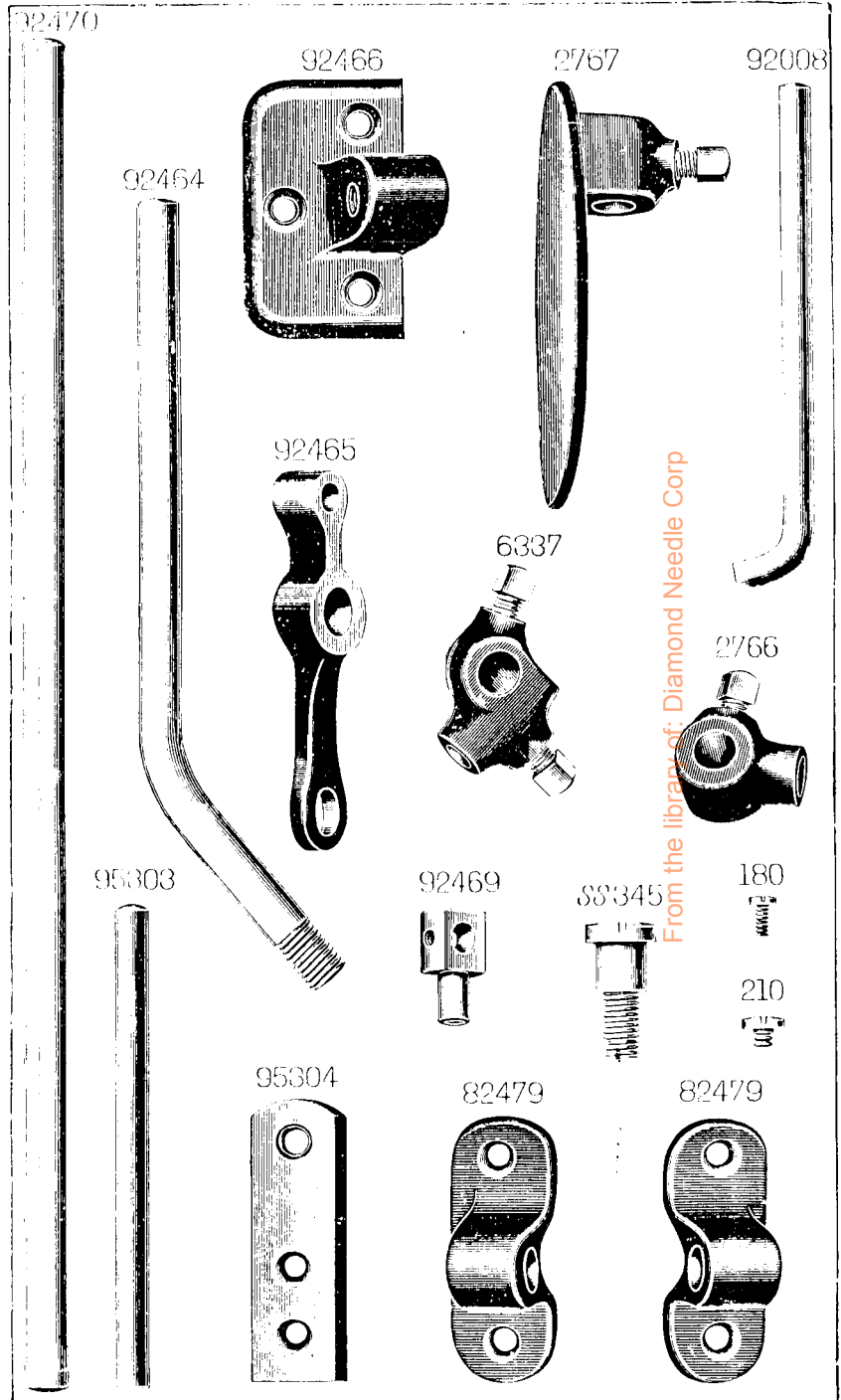

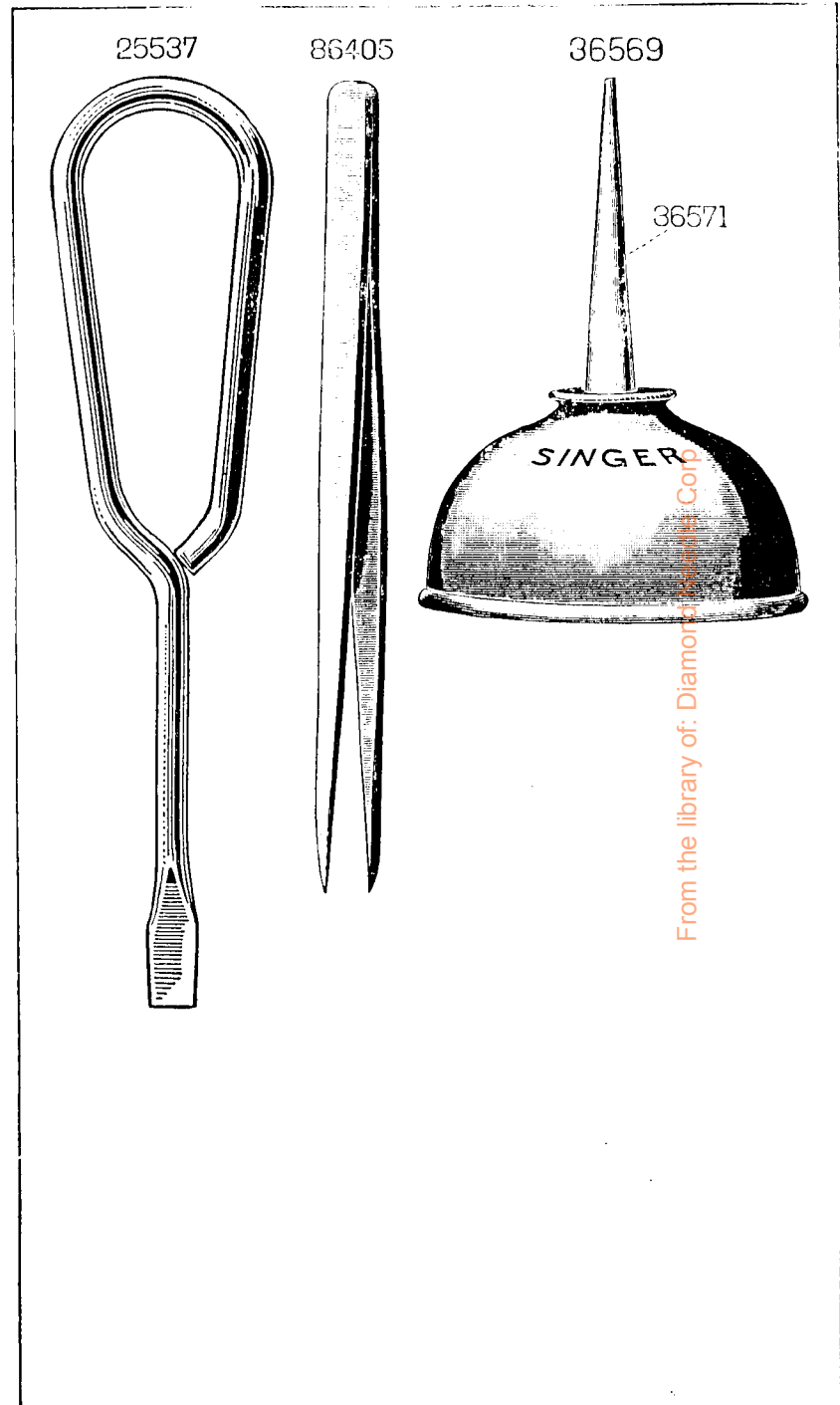
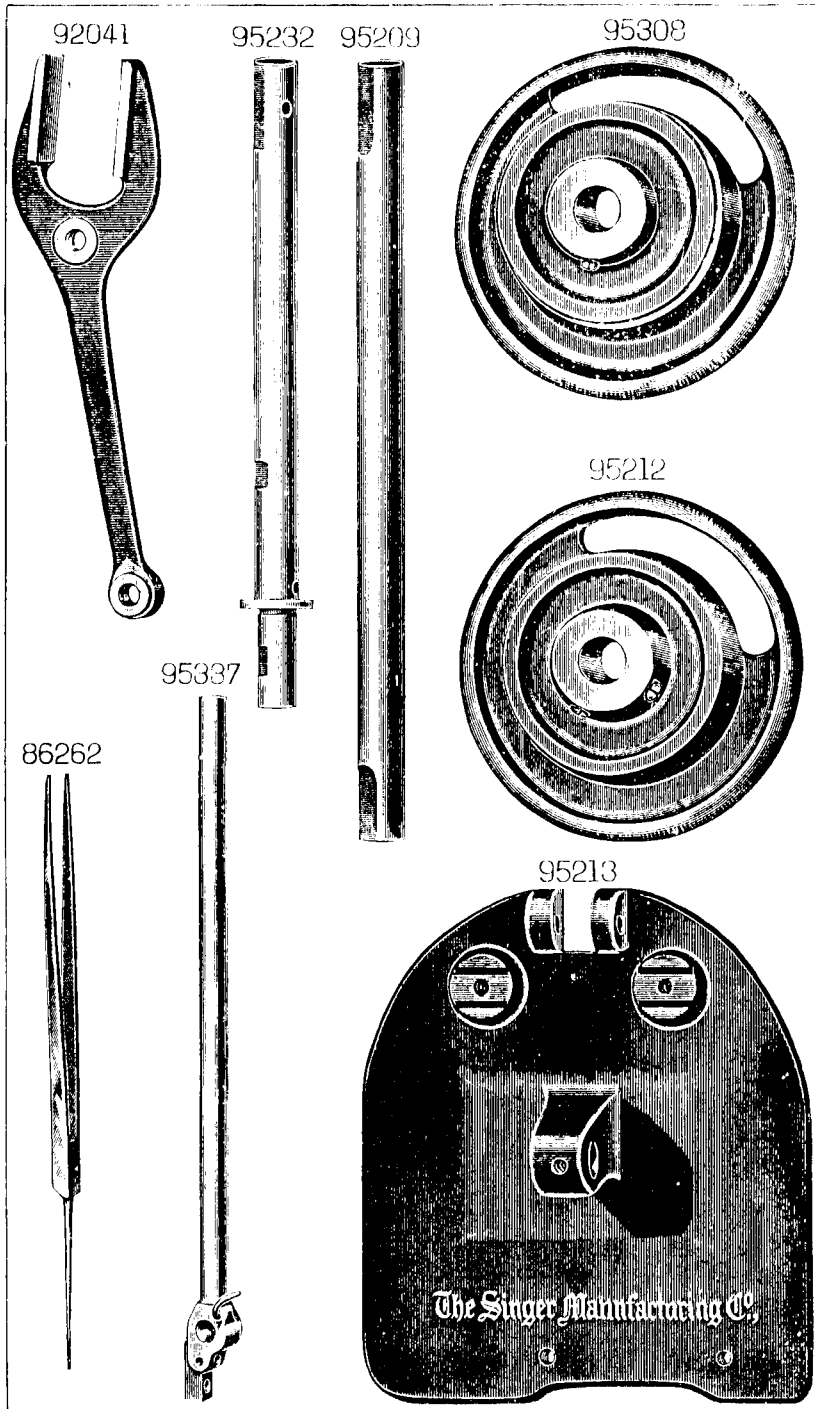

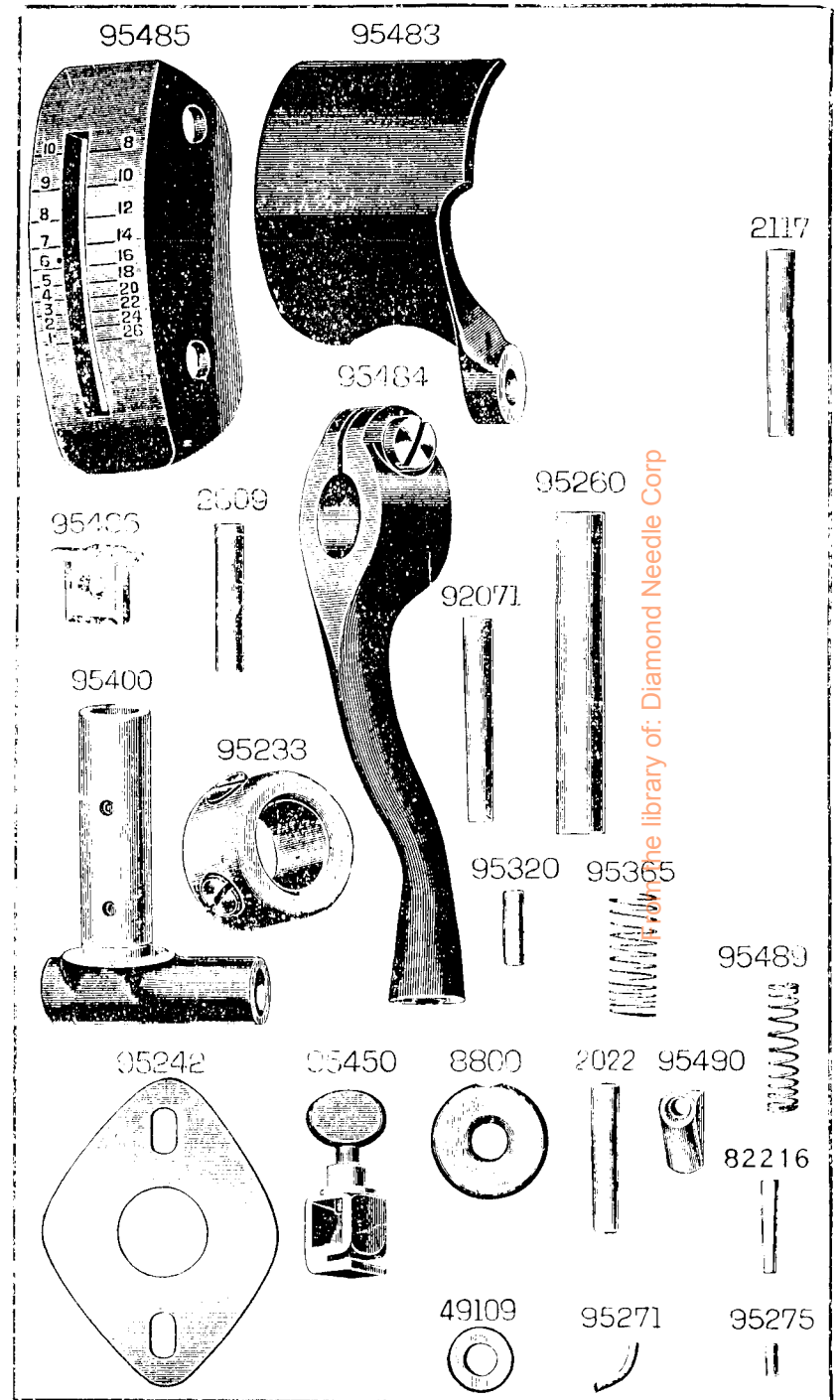
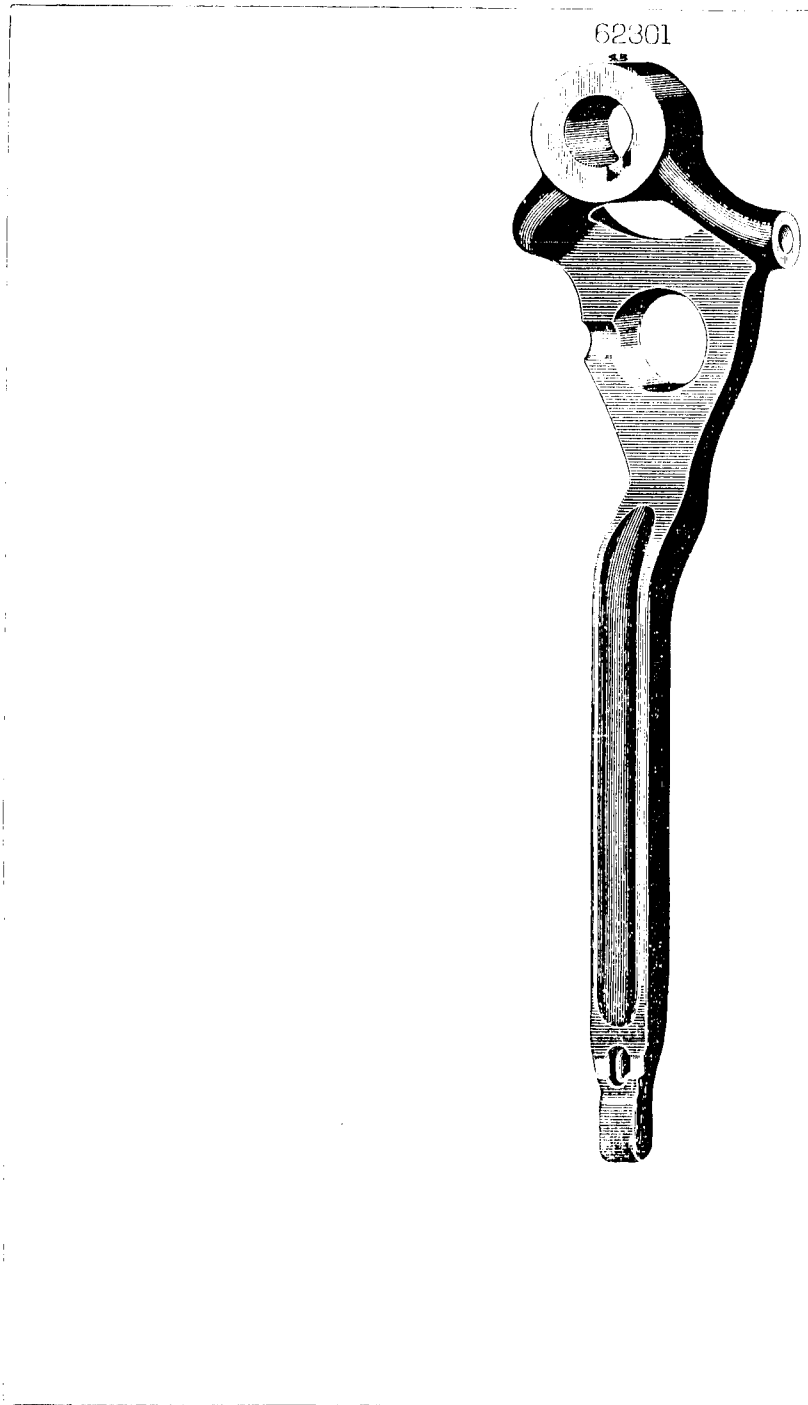

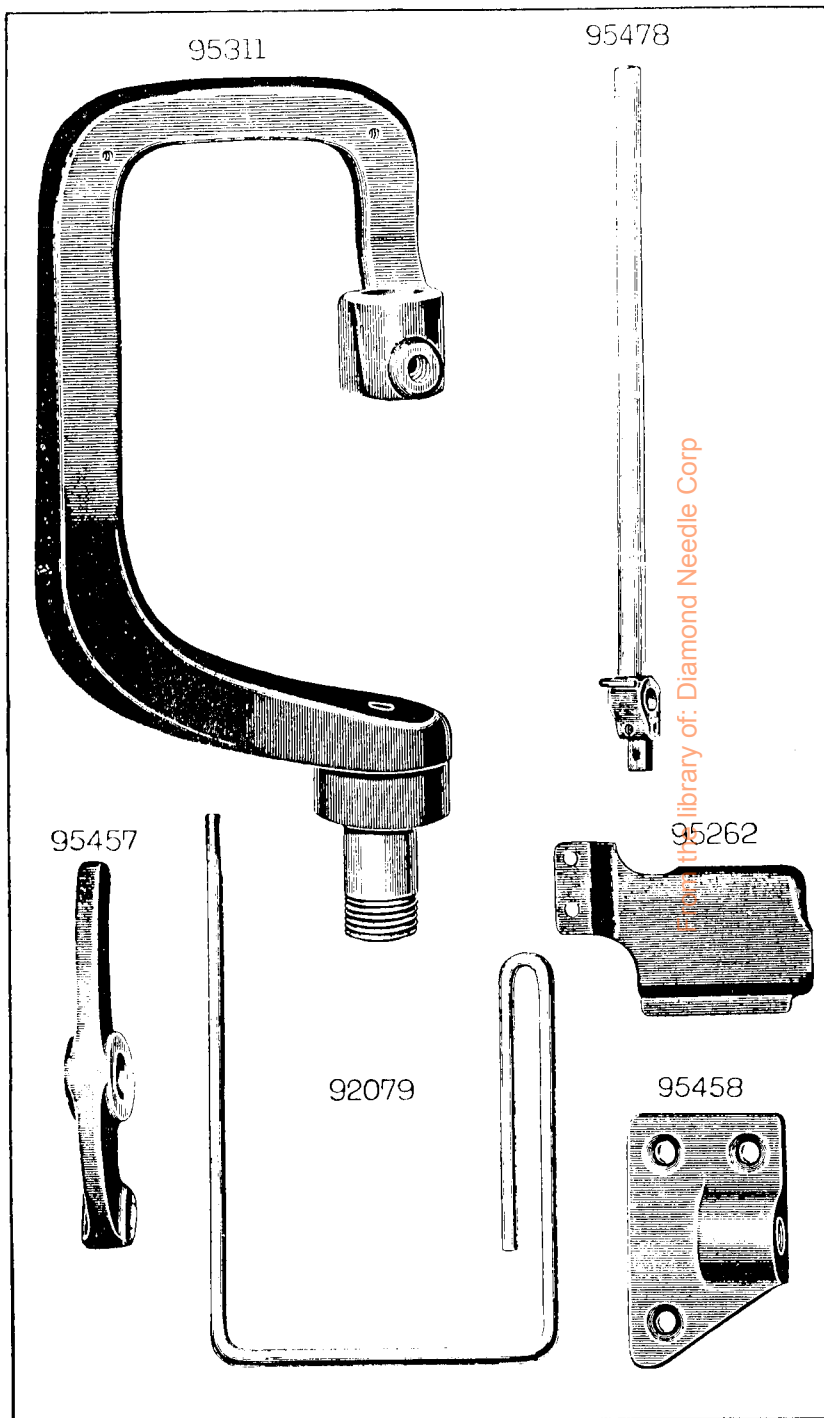
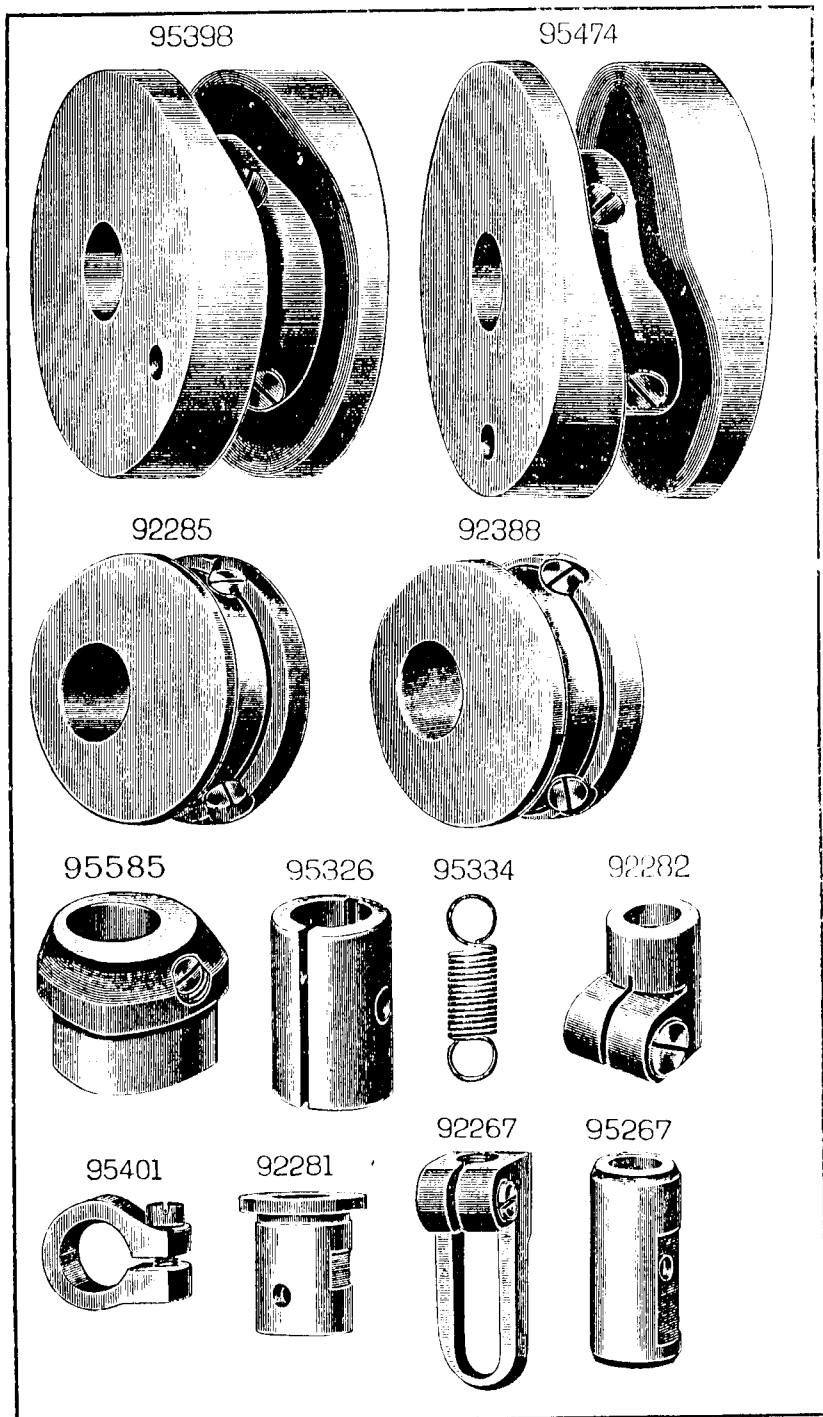

Library of: Diamond Needle Corp

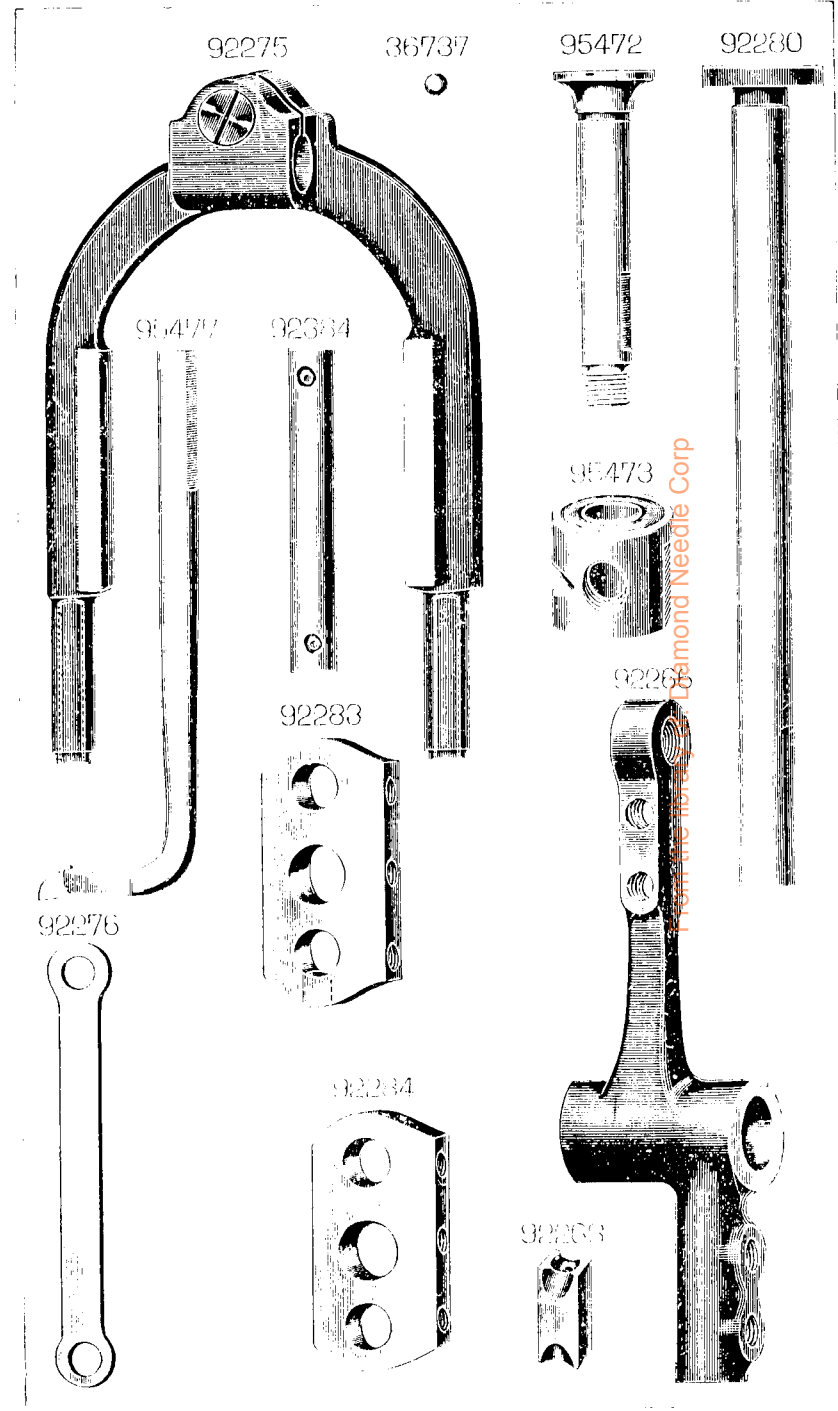
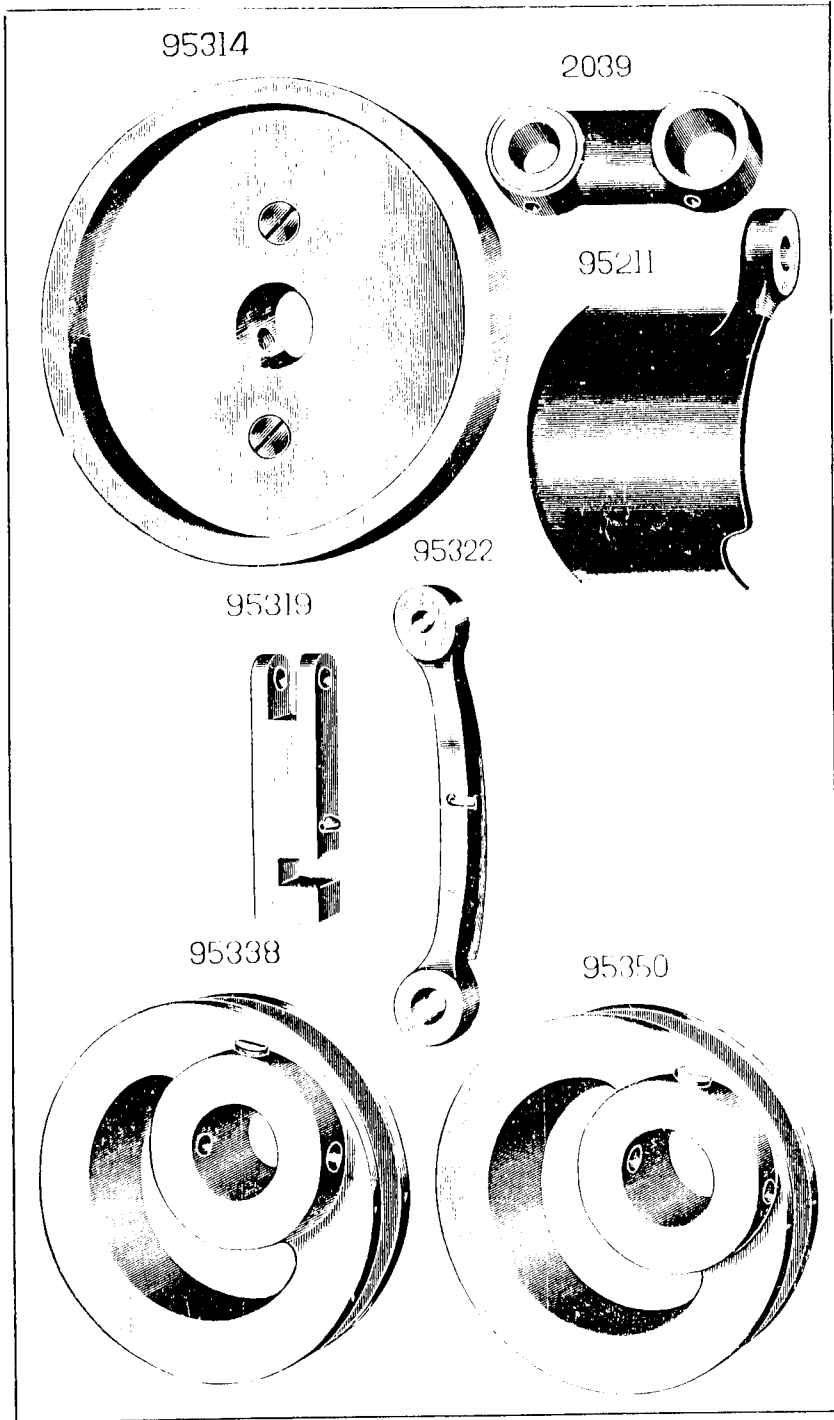

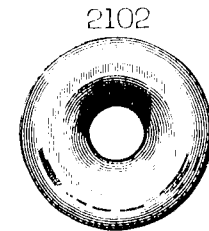
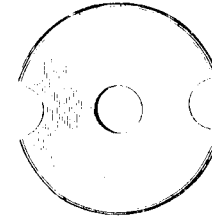
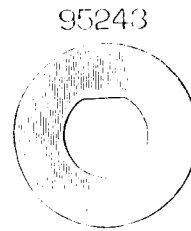
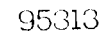
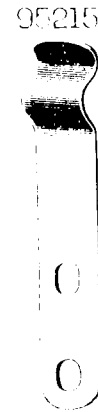
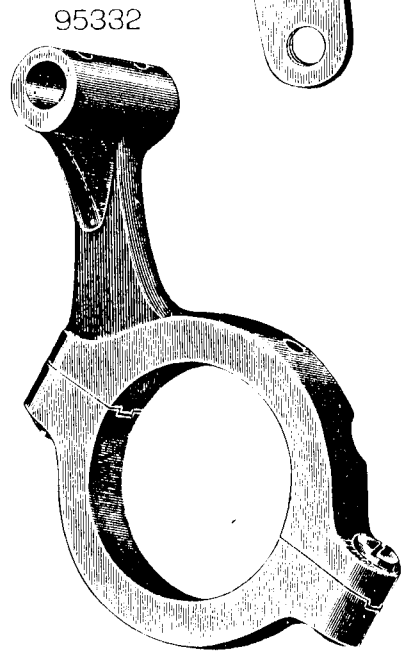
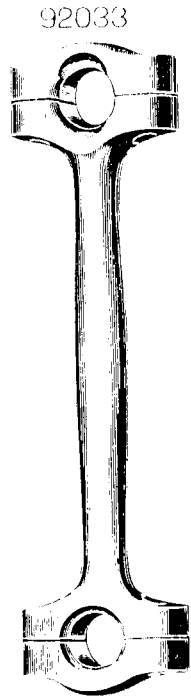
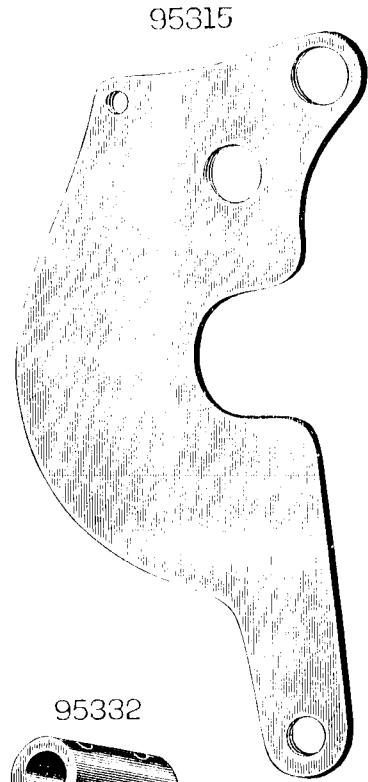

from the library of: Diamond Needle Corp

95567

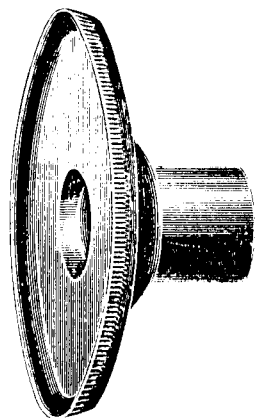

95574

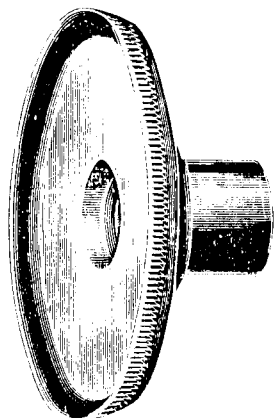

95569

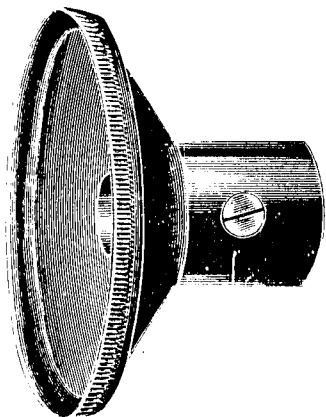

95576

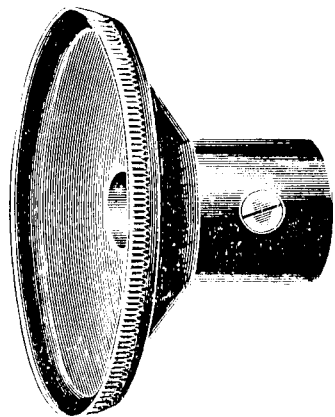

95560



95561

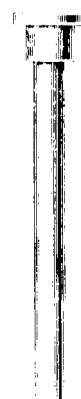

95562

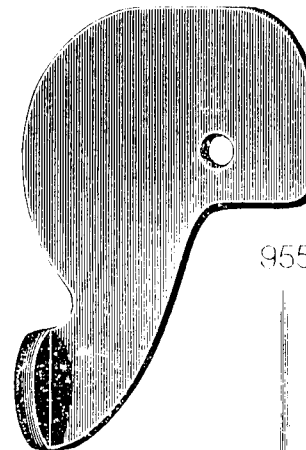

95564



184



1633



95563



From the library of: Diamond Needle Corp.

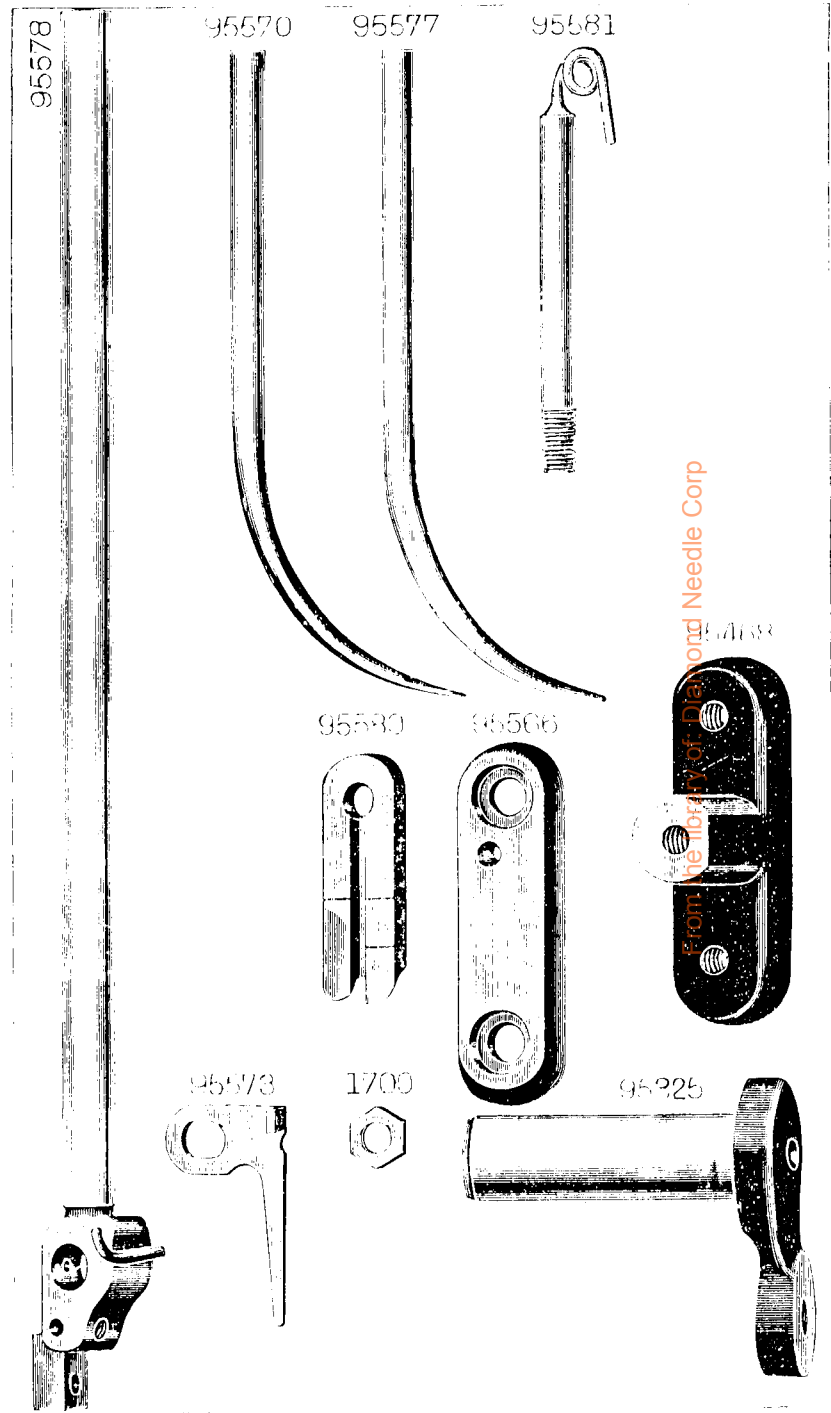
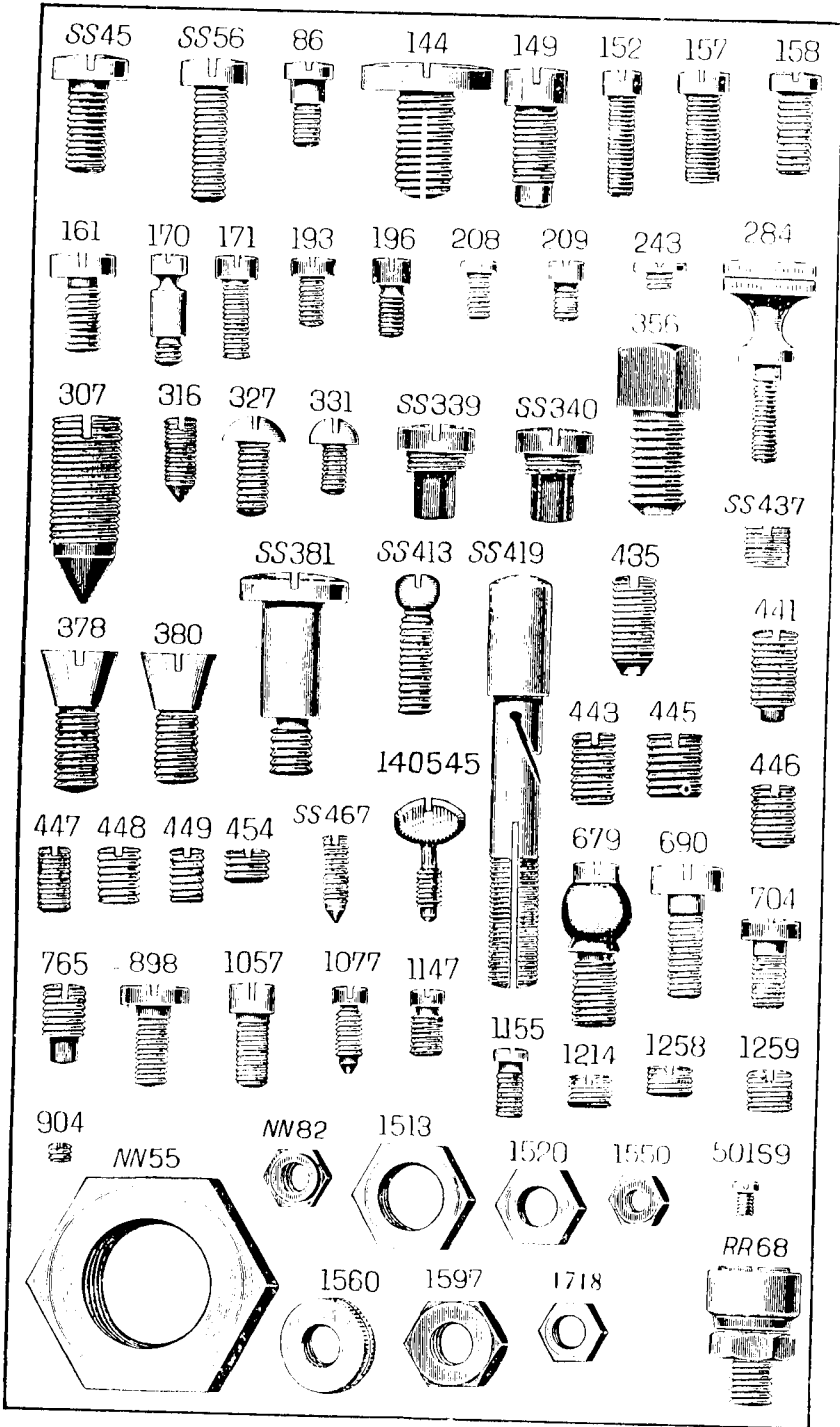

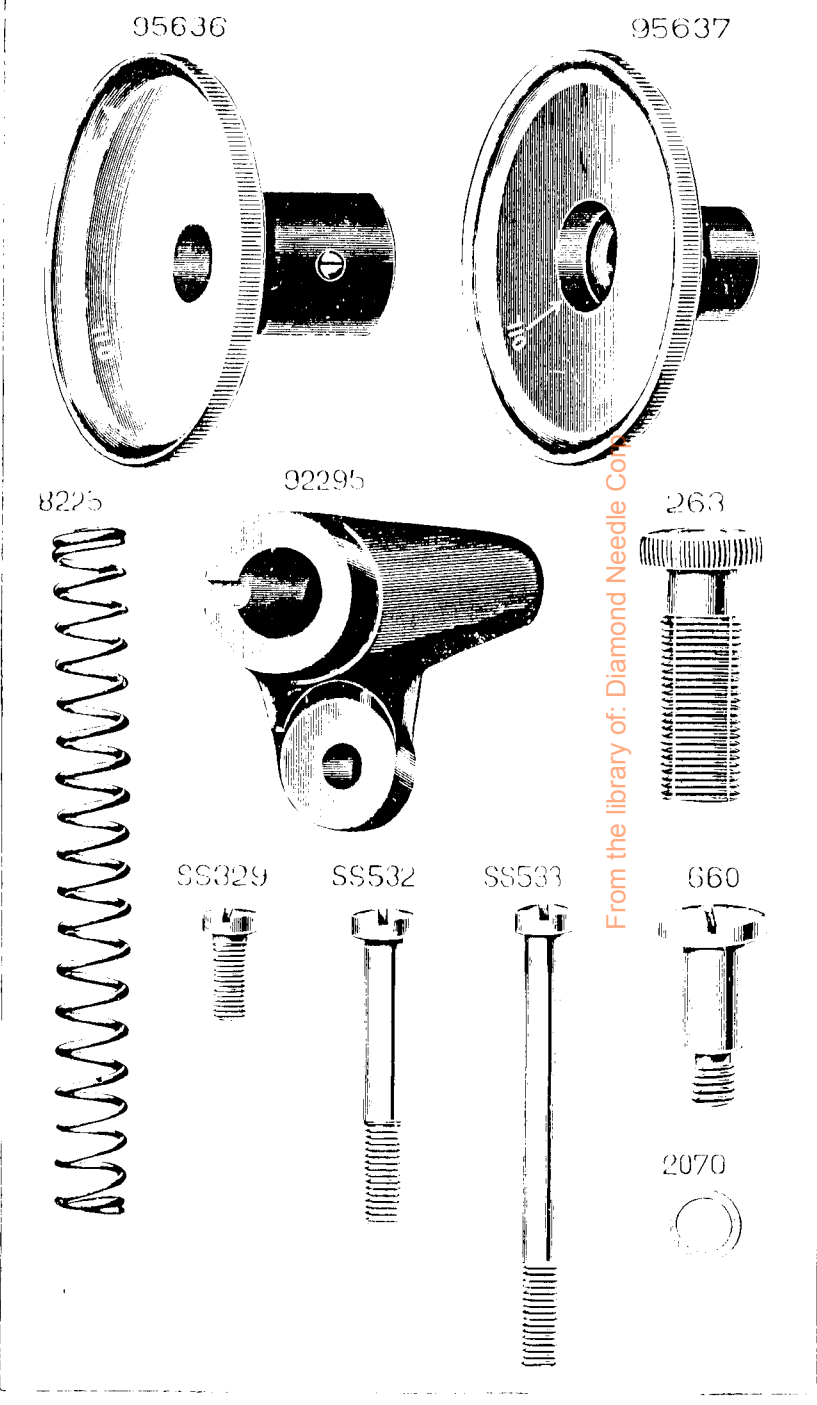
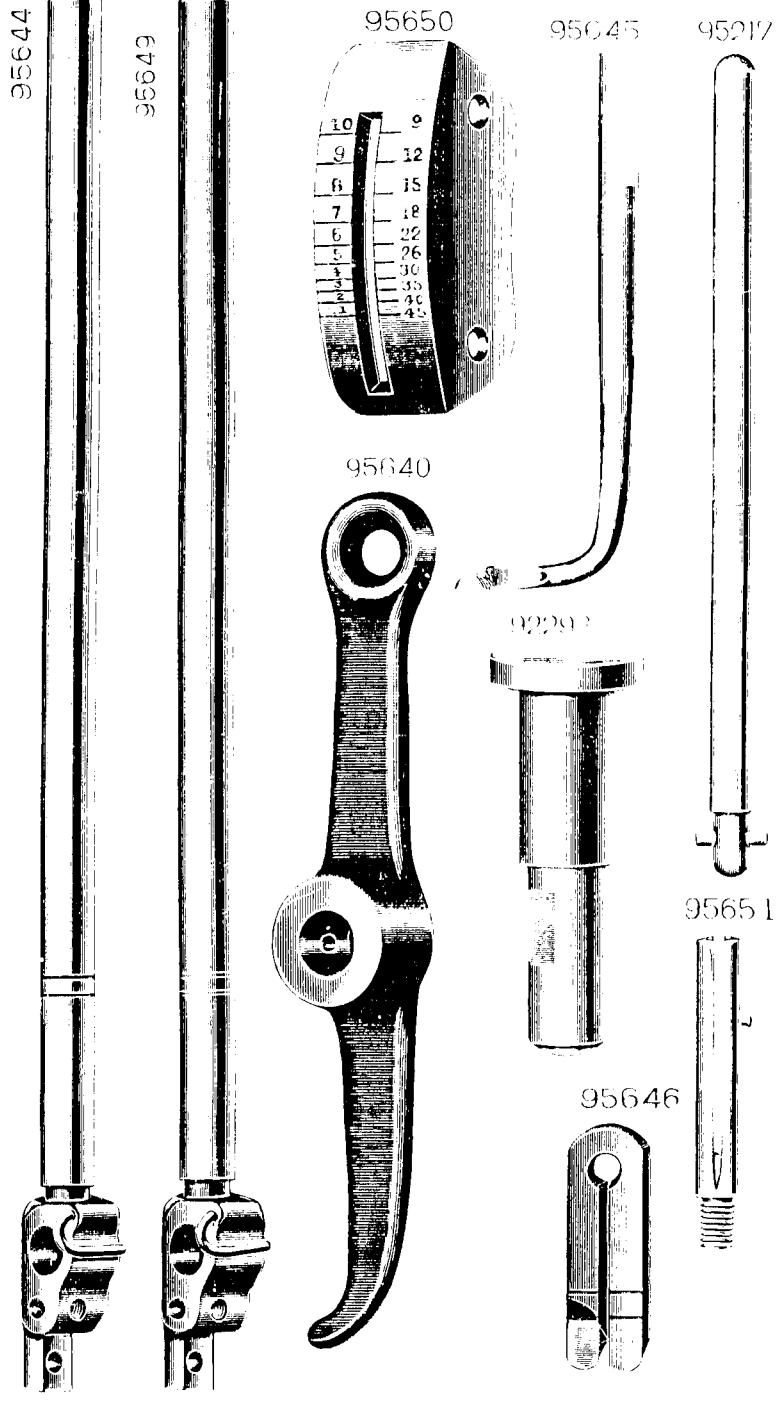

From the library of: Diamond Needle Co.

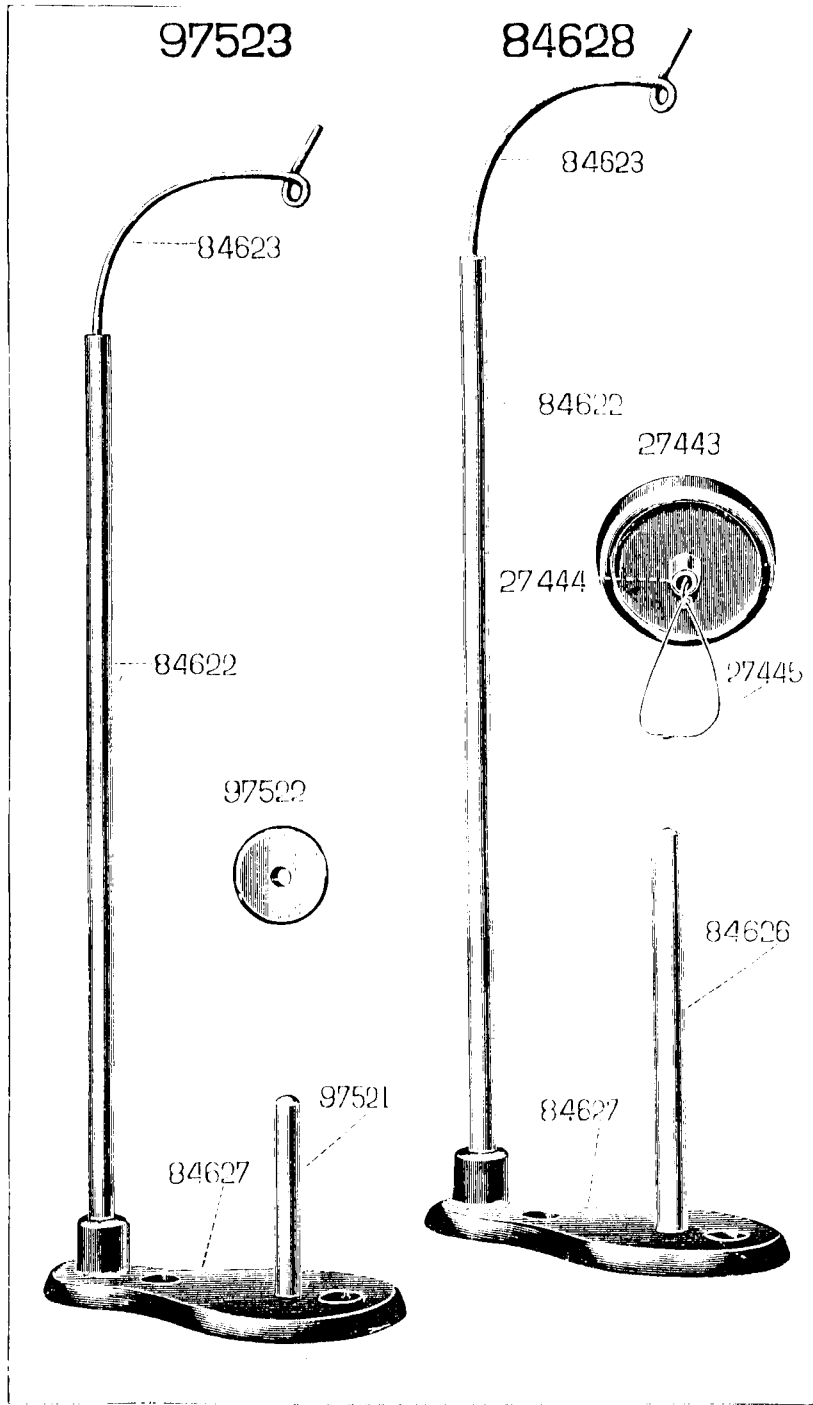

INSTRUCTIONS FOR ORDERING

In ordering from this List, the prefix and affix letters with the part number **MUST BE** quoted exactly as they are shown in the first column.

A number always indicates the same part in whatever List it may appear on or for whatever machine.

The affix letters (where shown) indicate the style of finish, as follows:

- A. Hardened, Polished, Nickel Plated and Buffed.
- A.A. Buffed and Chromium Plated.
- A.B. Hardened, Polished, Buffed and Chromium Plated.
- A.C. Brown Baking Enamel Finish.
- A.D. Grey Baking Enamel Finish.
- A.E. Hardened, Bright Rumbled and Nickel Plated.
- A.F. Hardened, Bright Rumbled and Nickel Plated, Bright Rumbled and Chromium Plated.
- A.J. Polished, Nickel Plated and Chromium Plated.
- A.K. Hardened, Polished, Nickel Plated and Chromium Plated.
- A.L. Heat Treated for Toughness.
- A.L.X. Heat Treated for Toughness and Black Oxide.
- A.P.P. Grey Wrinkle.
- B. Polished, Nickel Plated and Buffed.
- C. Hardened only.
- C.R. Hardened and Phosforic Treated.
- D. Polished only.
- E. Soft, not Polished.
- F. Hardened and Polished.
- F.J. Hardened, Polished and Nickel Plated.
- G. Bright Rumbled and Nickel Plated.
- H. Blued.
- J. Nickel Plated only.
- K. Hardened and Nickel Plated.
- L. Brass Plated.
- M. Oxidized.
- N. Japanned, Dull.
- P. Japanned, Bright.
- P.P. Wrinkle Finish.
- R. Phosforic Treated.
- S. Cadmium Plated.
- T. Copper Plated.
- T.A. Hardened, Polished, Copper and Nickel Plated and Buffed.
- T.B. Copper and Nickel Plated and Polished.
- T.J. Copper and Nickel Plated only.
- T.K. Hardened, Copper and Nickel Plated.
- T.L. Copper and Brass Plated.
- T.M. Copper Plated and Oxidized.
- U. Zinc Plated.
- V. Silver Plated.
- W. Polished and Nickel Plated.
- X. Black Oxide for Iron and Steel.
- X.C. Hardened and Black Oxide for Iron and Steel.
- Y. Black Nickel Plated only.
- Z. Chromium Plated.
- Z.A. Hardened, Polished, Nickel Plated, Buffed and Chromium Plated.
- Z.B. Polished, Nickel Plated, Buffed and Chromium Plated.
- Z.C. Hardened and Chromium Plated.
- Z.D. Polished and Chromium Plated.
- Z.G. Bright Rumbled, Nickel Plated, Bright Rumbled and Chromium Plated.
- Z.J. Nickel and Chromium Plated.
- Z.T. Copper and Chromium Plated.

Parts marked with an asterisk (*) are furnished only when the repairs are made at Factory.

Parts Complete for No. 46K48 Machine

For Fine Fur Work (Surjeteuse) fitted with Stitch Regulator with Indicator, Friction Feed Motion and Ball-Bearing Front Feeding Disc. Single Thread Chain Stitch.

No.	Plate	Description
95213	1026	Cover Plate
95584		Cover Plate, complete, Nos. 331d, SS419f, 1560f, 19109, 95213, 95352, 95573, 95652 and two 2102
	2117	Cover Plate Hinge Pin
95213	1729	" " Latch Spring
	1931	" " " " Screw (2)
62301	1492	Feed Adjusting Lever with 416
	416	" " " " Set Screw
	307	" " " " Screw Centre (2)
	1513j	" " " " " " Nut (2)
92100	1729	" " " " Spring
95560	1734	" " " " " " Guide with 82216
95561	1734	" " " " " " Plunger
82216	1723	" " " " " " Position Pin
95562	1734	" " " " " " Regulator
	184	" " " " " " Hinge Screw
95563	1734	" " " " " " Plunger
95564	1734	" " " " " " Sleeve
	1633	" " " " " " Nut
95565		Feed Adjusting Lever Spring Regulator, complete, Nos. 184, 1633, and 95560 to 95564
92295	1830	Feed Bell Crank
92017		" " " " Connecting Rod
92033	1728	" " " " " " 92017 with 92034, 92256 and four 196d
92034		" " " " " " Cap (plain countersink) for Friction Driver Universal Joint Screw
92256		" " " " " " Connecting Rod Cap (elongated countersink) for Bell Crank Universal Joint Screw
	196d	" " " " " " Connecting Rod Cap Binding Screw
92293	1829	" " " " " " Fulcrum Stud
	418	" " " " " " Set Screw
	679c	" " " " " " Universal Joint Screw

From the library of: Diamond Needle Corp

No.	Plate							
95311	1725	Feed Bracket (front)
NN55c	1736	" " Nut
95585	1724	Feed Cam with 443c
443c	1736	" " Set Screw
2039	1726	Feed Connecting Link
380c	1736	" " " Hinge Screw (2)
1520r	1736	" " " Nut (2)
92041	1026	Feed Forked Connection
378c	1736	" " " Hinge Screw
1520r	1736	" " " Nut
95232	1026	Feed Friction Shaft (upright)
SS45d	1736	" " " End Screw
95313	1729	" " " Washer
95242	1723	" " " Friction Spring
765ad	1736	" " " Tension Screw
95243	1729	" " " Washer
95233	1723	" " " Position Collar with 1258c and 1259c
1258c	1736	" " " Set Screw (short)
1259c	1736	" " " " (long)
95314	1726	Feed Friction Wheel with 435c, 444d and two 765ad
444d	1736	" " " Position Screw
435c	1736	" " " Set Screw
95315	1728	Feed Friction Wheel Driver
95316	1729	" " " Block (inside)
SS339c	1736	" " " (") Screw Stud
95317	1729	" " " (outside)
SS340c	1736	" " " (") Screw Stud
243c	1736	" " " End Screw
94967	1729	" " " Spring
95230	1728	" " " Hook
170c	1736	" " " Screw Stud
679c	1736	" " " Universal Joint Screw
1520r	1736	" " " Nut
95318		Feed Friction Wheel Driver , complete, Nos. 170c, 243c, SS339c, SS340c and 95315 to 95317

No.	Plate							
95319	1726	Feed Friction Wheel Retaining Clutch with 95271
95322	1726	" " " Bracket with 95271
95271	1723	" " " Spring Hook
690c	1736	" " " Screw
95320	1723	" " " Hinge Pin
95334	1724	" " " Spring
95274	1723	" " " Hook
95323		Feed Friction Wheel Retaining Clutch , complete, Nos. 95319, 95320 and 95322
95481	1723	Feed Regulating Lever with 4581
4581	1736	" " " Binding Screw
95485	1723	" " " Segment
161c	1736	" " " Screw (2)
95486	1723	" " " Stitch Indicator
284d	1736	" " " Thumb Screw
95375	1828	Feed Regulator
95376	1724	" " " Bush
4491	1736	" " " Set Screw
389c	1736	" " " Hinge Screw
1520r	1736	" " " Nut
95640	1829	Feed Roll Opening Lever
95644		" " " 95640 with 660d
660d	1830	" " " Hinge Screw
95567	1733	Feeding Disc (front)
36737	1727	" " " Ball, 1/2" diam
95472	1727	" " " Stud
95473	1727	" " " Bushing
445c	1736	" " " Binding Screw
316c	1736	" " " Raising Set Screw
1216c	1736	" " " Set Screw
4597c	1736	" " " Nut
95568		Feeding Disc (front, ball bearing), complete, Nos. 1216c, 4597c, 95472, 95473, 95567 and twenty 36737
95569	1733	Feeding Disc (back) with 454d
454d	1736	" " " Set Screw
95570	1828	Fur Guide
1521	1736	" " " Binding Screw
95242	1026	Hand Wheel with two 448c
448c	1736	" " " Set Screw

No.	Plate	
95487		Head of Machine
SS56d	1736	" " " Binding Screw (2)
95645	1829	Looper
1147c	1736	" Binding Screw (2)
92266	1727	" Holder
92288	"	" " 92266 with RR68
95244		Looper Holder Connection , complete, Nos. 209d, SS467c, 1077c, 1550h, 92280, 92283, 92284, 92288, 92384, 92388, 95260, 95332, 95400, 95401 and four 1155c
92267	1724	Looper Holder Position Link with 171c
95468	1828	" " " " Bracket
95566	1828	" " " " " Plate
SS56d	1736	" " " " " Binding Screw (2)
2022	1723	" " " " " Steady Pin
92268	1727	" " " " " Distance Rod
SS437c	1736	" " " " " End Screw
171c	1736	" " " " " Binding Screw
SS413c	1736	" " " " " Universal Joint Screw
1718b	1736	" " " " " Nut (bottom)
NN82c	1736	" " " " " Nut (top)
92269		Looper Holder Position Link , complete, Nos. SS437c, 92267, 92268 and two SS413c
92283	1727	Looper Holder Rock Shaft Bracket (right side)
SS467c	1736	" " " " " (" ") Adjusting Screw
1550h	1736	" " " " " (" ") Adjusting Screw Nut
92284	1727	" " " " " (left side)
1155c	1736	" " " " " Set Screw
92388	1724	" " " " " Eccentric with two 446
95332	1728	" " " " " Connecting Rod with 95333 and two 1057e
*95333		" " " " " Connecting Rod Cap
1057e	1736	" " " " " Screw
95260	1723	" " " " " Stud
446c	1736	" " " " " Set Screw
95400	1723	" " " " " Fulcrum Joint
95401	1724	" " " " " Collar with 171c
171c	1736	" " " " " Binding Screw
92384	1727	" " " " " Stud
209d	1736	" " " " " Set Screw
1077c	1736	" " " " " Spot Screw
95262	1725	" " " " " Oil Cover

No.	Plate	
92280	1727	Looper Holder Rock Shaft Stud
92281	1724	" " " " " Bushing
117c	1736	" " " " " Set Screw
92282	1724	" " " " " Collar with 704c
704c	1736	" " " " " Clamping Screw
RR68	1736	" " " " " Roller and Screw Stud with 378c and 1520c
378c	1736	" " " " " Screw
1520c	1736	" " " " " Nut
95264		Machine Base
S291	1729	" " " Hinge Connection
2809	1723	" " " " Pin
95265		Machine Base , complete, Nos. 95264, two each 2809 and S291
95308	1026	Machine Driving Pulley with two 448c
448c	1736	" " " " " Set Screw
95309	1026	" " " " " Shaft
444	1736	" " " " " End Screw (2)
95398	1724	" " " " " Looper Cap (Steel) with two 445c
445c	1736	" " " " " Set Screw
95211	1726	" " " " " Oil Hole Cover (right)
95483	1723	" " " " " (left)
86d	1736	" " " " " Hinge Screw (2)
95644	1829	Needle Bar with 95357
95267	1724	" " " Bushing
443	1736	" " " " " Set Screw
95268	1729	" " " " " Clamp with 110545c
110545c	1736	" " " " " Thumb Screw
95338	1726	" " " " " Eccentric with 449c
92074	1723	" " " " " Dowel Pin
92275	1727	" " " " " Fork with SS329c
SS329c	1830	" " " " " Clamping Screw
92276	1727	" " " " " Strap
208c	1736	" " " " " Screw
92277		" " " " " complete, Nos. 92275, 92276 and two 208c
449c	1736	" " " " " Set Screw
95357	1728	" " " " " Thread Guide
95298	1729	" " " " " Ripper
95489	1723	" " " " " Spring
95300	1728	" " " " " Adjusting Bracket
504c	1736	" " " " " Set Screw

No.	Plate	
95649	1829	Needle Bar with 95357
95490	1723	" " Needle Stop
50169d	1736	" " " " Screw
95647		Needle Bar , complete, Nos. 50169d, 95490 and 95649

NOTE. Needle Bar No. 95647 is sent with this Machine unless otherwise specified on order.

95646	1829	Needle Guide with two 95275
898f	1736	" " Binding Screw
95275	1723	" " Position Pin
92079	1725	Reel Holder
327d	1736	" " Binding Screw (2)
8800	1723	" " " " Washer (2)
2102	1729	Tension Disc
SS419l	1736	" Screw Stud and Thread Guide
331d	1736	" " " " Set Screw
1560d	1736	" " " " Thumb Nut
95352	1729	" Spring
95573	1828	Thread Guide for Cover Plate
49109	1723	" " Washer
95340	1729	Thread Nipper Spindle
171c	1736	" " " " Binding Screw
95651	1829	Thread Take-up Post with 95367
95365	1723	" " Spring
95366	1729	" " " " Collar
95367		" " " " Stop Pin
95652		Thread Take-up , complete, Nos. 95365, 95366 and 95651
95639		Drip Pan with two each SS532d and Wood Screws $\frac{1}{4}$ " No. 10, for machines without Iron Base (1 $\frac{1}{2}$ " tables)
95648		Drip Pan with two each SS533d and Wood Screws $\frac{1}{4}$ " No. 10, for machines on Power Tables (1 $\frac{3}{4}$ " tables)
SS532d	1830	Drip Pan Screw for 95639
SS533d	1830	" " " " 95648

NOTE. As the machines are regularly fitted with Iron Base, Drip Pans are only supplied when specified on order.

Parts Special to No. 46K49 Machine

For Fur Work (Surjeteuse), fitted with Stitch Regulator with Indicator, Friction Feed Motion and Ball-Bearing Front Feeding Disc. Single Thread Chain Stitch.

This machine is the same as No. 46K48 with the following exceptions:—

No.	Plate	
95583		Cover Plate , complete, Nos. 331d, SS419l, 1560d, 1700c, 49109, 95213, 95352, 95581 and two 2102
95574	1733	Feeding Disc (front)
95575		Feeding Disc (front, ball bearing), complete, Nos. 1214c, 1597c, 95472, 95473, 95574 and twenty 36737
95576	1733	Feeding Disc (back) with 454d
95577	1828	Fur Guide
95477	1727	Looper
95480		Looper Holder Connection , complete, Nos. 209d, SS467c, 1077c, 1550h, 92280, 92283 to 92285, 92288, 92381, 95260, 95332, 95400, 95401 and four 1155c
92285	1724	Looper Holder Rock Shaft Eccentric with two 416c
95474	1724	Machine Driving Pulley Shaft Looper Cam (steel) with two 415c
95478	1725	Needle Bar with 95357
95450	1723	" " Clump with 110545c
95350	1726	" " " " Eccentric with 119c
95578	1828	Needle Bar with 95357
95579		Needle Bar , complete, Nos. 50169d, 95490 and 95578
95580	1828	Needle Guide with two 95275
95581	1828	Thread Guide for Cover Plate
1700c	1828	" " " " Nut

NOTE. Needle Bar No. 95579 is sent with this machine unless otherwise specified on order.

Parts Special to No. 46K53 Machine

(OBSOLETE)

For Linen and Handkerchief Work, fitted with Stitch Regulator with Indicator, Friction Feed Motion and Ball-Bearing Front Feeding Disc, Single Thread Chain Stitch.

This machine is the same as No. 46K48 with the following exceptions:

No.	Plate		
95217	1829	Feed Adjusting Lever Spindle with 82216	...
82216	1723	" " " " Position Pin	...
8225	1830	Feed Adjusting Lever Spring	...
2636	1830	" " " " Regulating Thumb Screw	...
2070	1830	" " " " Washer	...
95650	1829	Feed Regulating Lever Segment	...
95637	1830	Feeding Disc (front)	...
95638		Feeding Disc (front, ball bearing), complete, Nos. 1214c, 1597c, 95472, 95473, 95637 and twenty 36737	...
95636	1830	Feeding Disc (back) with 1544	...
95639		Drip Pan with two each S8532d and Wood Screws $\frac{1}{16}$ " No. 10, for machines without Iron Base $\frac{1}{16}$ " table)	...
95648		Drip Pan with two each S8533d and Wood Screws $\frac{1}{16}$ " No. 10, for machines on Power Table $\frac{1}{16}$ " table)	...
S8532d	1830	Drip Pan Screw for 95639	...
S8533d	1830	" " " " 95648	...

NOTE. Machine Base (Iron) No. 95265 is not regularly supplied with this machine, but it can be furnished in place of Drip Pan if specified on order.

Accessories

No.	Plate	
215 × 17		Needles , three each sizes 7 and 11, for 46K48 Machine
215 × 15		" " " " " 11 and 16, for 46K49 Machine
215 × 17		" " " " " six size 1, for 46K53 Machine
36569	1355	Oiler
25537	1355	Screw Driver
86262	1026	Tweezers , for 46K48 and 46K49 Machines
86405	1355	" " " " 46K53 Machine
		Wood Screw 1½" × 1" (3) (for fixing machine to table)

Knee Lifter

No.	Plate	
2767	1023	Knee Plate with 356
356c	1736	" " " " Set Screw
92464	1023	" " " " Arm
2766	1023	" " " " Bracket with 356c
356e	1736	" " " " " " Set Screw
92465	1023	Lifting Lever
SS345e	1023	" " " " Hinge Screw
92466	1023	" " " " Bracket
		" " " " " " Screw (Wood) 1" No. 10
92008	1023	" " " " Connecting Rod
92009		" " " " " " 92008 with 6337
6337	1023	" " " " " " Bracket with two 356c
356e	1736	" " " " " " " " Set Screw
95302		" " " " 92465 with 180d, 210d, SS345e, 92466, 92469 and 95303
95303	1023	" " " " Releasing Pin
95304	1023	" " " " " " Guide Plate
		" " " " " " " " Screw (Wood) 1" No. 10
180d	1023	" " " " " " " " Set Screw
92469	1023	" " " " Stud
210d	1023	" " " " " " Position Screw

No.	Plate	
92470	1023	Rock Shaft
92471		" " " " 92470 with 2766, 2767, 92009 and 92464
82479	1023	" " " " Bracket
		" " " " " " Screw (Wood) 1" No. 10
95305		Knee Lifter , complete, Nos. 92471, 95302, 95304, two 82479 and nine Wood Screws 1" No. 10

Knee Lifter

for Machines WITHOUT Iron Base when used on Stand and Table only.

No.	Plate	
2767	1023	Knee Plate with 356
356e	1736	" " " " Set Screw
92464	1023	" " " " Arm
2766	1023	" " " " " " Bracket with 356c
356e	1736	" " " " " " " " Set Screw
95457	1725	Lifting Lever
SS345e	1023	" " " " Hinge Screw
95458	1725	" " " " Bracket
		" " " " " " Screw (Wood) 1" No. 10
92008	1023	" " " " Connecting Rod
92009		" " " " " " 92008 with 6337
6337	1023	" " " " " " Bracket with two 356c
356e	1736	" " " " " " " " Set Screw
95459		" " " " 95457 with SS345e and 95458
92470	1023	Rock Shaft
92471		" " " " 92470 with 2766, 2767, 92009 and 92464
82479	1023	" " " " Bracket
		" " " " " " Screw (Wood) 1" No. 10
95499		Knee Lifter , complete, Nos. 92471, 95459, two 82479 and seven Wood Screws 1" No. 10

Thread Unwinder

For one spool of thread for 46K53 Machine.

No.	Plate	
84626	1898	Spool Pin (1" high)
84627	1898	" Rest
27443	1898	" Weight with 27444 and 27445
27444	1898	" " Centre
27445	1898	" " Thread Guide
84622	1988	Thread Eyelet Rod
84623	1898	" " Wire
84624		" " " 84623 with 84622
84628	1898	Thread Unwinder , complete, Nos. 27443, 84624, 84626, 84627 and two Wood Screws E No. 12

Thread Unwinder

For one small spool of thread for 46K53 Machine.

No.	Plate	
97521	1898	Spool Pin (2" high)
84627	1898	" Rest
97522	1898	" Weight
84622	1898	Thread Eyelet Rod
84623	1898	" " Wire
84624		" " " 84623 with 84622
97523	1898	Thread Unwinder , complete, Nos. 84624, 84627, 97521, 97522 and two Wood Screws E No. 12

NOTE: Thread Unwinder No. 84628 is supplied with machine unless otherwise specified on order.